

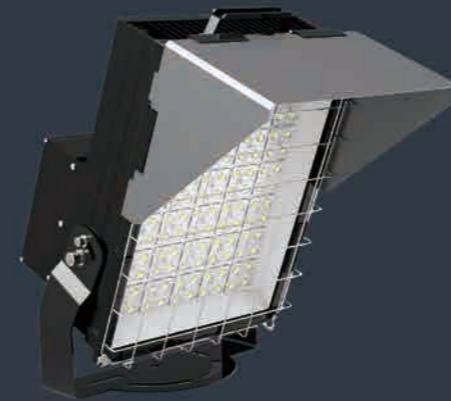

Light the Night



**TRIPower SOLAR & LED**

- 📍 Add: TriPower Solar & LED Port of Spain Trinidad
- ✉ Email: sales@tripowersolar.com
- 🌐 Web: www.tripowersolar.com

LED Manufacturer  
Lighting Solution Provider

**2020**

TRINIDAD



# ABOUT TRIPOWER

Tri Power Solar & LED

LED High Mast Lights

LED Highbay Lights

LED Flood Lights

LED Street Lights

TRI POWER SOLAR & LED is ESTABLISHED IN 2009, WELL-KNOWN OEM FACTORY FOR ASIA, AUSTRALIA, EUROPE AND AMERICA MARKET.

OUR GROUP IS AN OEM/ODM FACTORY FOCUSED ON THE DEVELOPMENT AND MANUFACTURING OF INDOOR/OUTDOOR LED LIGHTS, HAS GROWN TO OVER 100 WORKERS WITH OVER 60,000 SQ FEET OF WORKSHOP OUR MISSION IS TO DESIGN AND MANUFACTURE THE MOST HIGH PERFORMANCE LED PRODUCTS, WHILE OFFERING OUR CUSTOMERS UNBEATABLE PRICING AND A GUARANTY OF THE HIGHEST STANDARD OF QUALITY..

**HIGH QUALITY ONLY**

**WE PROVIDE OEM/ODM SERVICE**

**WE PROVIDE DIALux SOLUTION**

**WE PROVIDE TIMELY AFTERMARKET**

## 01 / LED HIGH MAST LIGHTS

01 - 02

LED High Mast Lights-ARES



03 - 04

LED High Mast Lights-CHAOS

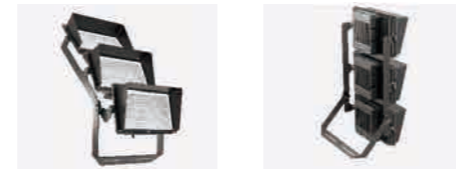

05 - 06

LED High Mast Lights-GAEA



## 02 / LED HIGH BAY LIGHTS

07 - 08

LED High Bay Lights-HELIOS

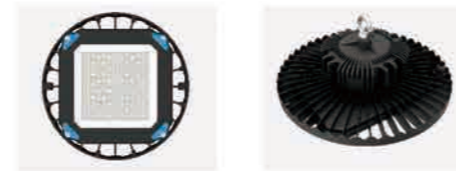

09 - 10

LED High Bay Lights-MOON



## 03 / LED FLOOD LIGHTS

11 - 12

LED Flood Lights-THEA



13 - 14

LED Flood Lights-RHEA



## 04 / LED STREET LIGHTS

15 - 16

LED Street Lights-THOR



17 - 18

LED Area Lights-ZEUS



## >> OTHERS

- A** Solar Products
- B** LED Tube Lights
- C** LED Panel Lights



- All Applications
- Baseball, Softball
- Harbours, Wharfs
- Soccer, Lacrosse
- Basketball, Tennis

## ARES LED HIGH MAST LIGHTS

400W 500W 600W 800W 1000W 1200W

**OPTICS LENS : 15° / 30° / 60° / 90° / 80\*135°**  
**REFLECTOR CUP : 17° / 24° / 36° / 60°**

## ARES LED HIGH MAST LIGHTS



**400W    500W    600W    800W    1000W    1200W**

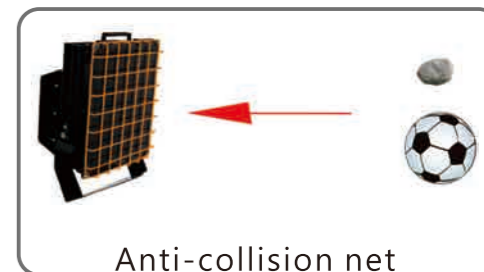

- 
- 
- 
- 
- 
- 
- 
- 
- 
- 
- 
- 
- 
- 

- Input Voltage: 90-305VAC/480VAC
- CCT: 3000K 4000K 5000K 5700K 6500K
- Beam Angle: 15° / 17° / 24° / 30° / 36° / 60° / 90° / 80\*135°
- Dimming Options: DALI/ DMX Dimmable
- IP Rating: IP67
- Light Source: Lumileds5050/Cree 3535

ITEM NO.	Wattage	Lumen	Efficiency	Driver	LED Chip	Dimensions
NL-ARES-HM400	400W	60,000Lm	150Lm/W	2 x EUP-200-S210	200pcs	48*41*31.5 cm
NL-ARES-HM500	500W	75,000Lm	150Lm/W	2 x EUP-240-S150	240pcs	54*41*31.5 cm
NL-ARES-HM600	600W	90,000Lm	150Lm/W	2 x EUP-320-S220	280pcs	59*41*31.5 cm
NL-ARES-HM800	800W	120,000Lm	150Lm/W	4 x EUP-200-S210	400pcs	76*48*31.5 cm
NL-ARES-HM1000	1000W	150,000Lm	150Lm/W	4 x EUP-240-S150	480pcs	76*54*31.5 cm
NL-ARES-HM1200	1200W	180,000Lm	150Lm/W	4 x EUP-320-S220	560pcs	76*59*31.5 cm

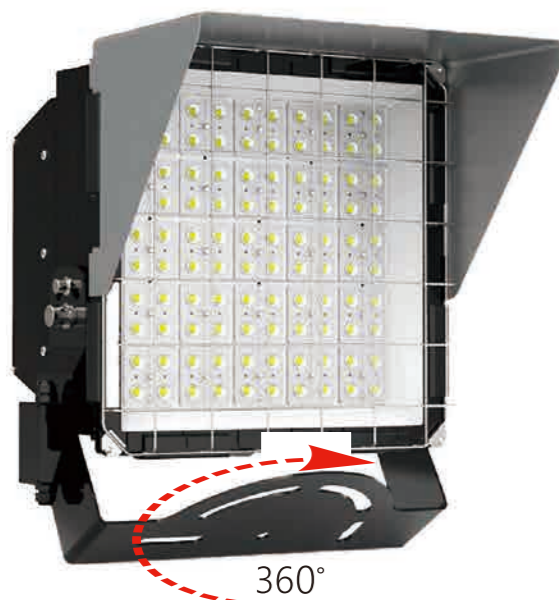



-  All Applications
-  Baseball, Softball
-  Harbours, Wharfs
-  Soccer, Lacrosse
-  Basketball, Tennis



**160**  
lm/w



**IP66**  
RATED



**CCT**  
2700-6500K

# CHAOS LED HIGH MAST LIGHTS

500W 600W 1000W 1200W 1500W 1800W

**OPTICS LENS:**  
7° / 15° / 30° / 60° / 90° / T2M / T3M



**500W / 600W**









**1000W / 1200W**



**1500W / 1800W**

- 
- 
- 
- 
- 
- 
- 
- 
- 
- 
- 
- 
- 
- 

-  Input Voltage: 90-305VAC/480VAC
-  CCT: 3000K 4000K 5000K 5700K 6500K
-  Beam Angle: 7° / 15° / 30° / 60° / 90° / T2M/T3M
-  Dimming Options: DALI/ DMX Dimmable
-  IP Rating: IP66
-  Light Source: Lumileds 3030/Cree3535

ITEM NO.	Wattage	Lumen	Efficiency	Driver	LED Chip	Dimensions
NL-CHAOS-HM500	500W	80,000Lm	160Lm/W	Meanwell/Inventronics	1200pcs	46.2*63.7*13.4cm
NL-CHAOS-HM600	600W	96,000Lm	160Lm/W	Meanwell/Inventronics	1200pcs	46.2*63.7*13.4cm
NL-CHAOS-HM1000	1000W	160,000Lm	160Lm/W	Meanwell/Inventronics	2400pcs	86.9*67.8*15.2cm
NL-CHAOS-HM1200	1200W	192,000Lm	160Lm/W	Meanwell/Inventronics	2400pcs	86.9*67.8*15.2cm
NL-CHAOS-HM1500	1500W	240,000Lm	160Lm/W	Meanwell/Inventronics	3600pcs	126.7*67.8*15.2cm
NL-CHAOS-HM1800	1800W	288,000Lm	160Lm/W	Meanwell/Inventronics	3600pcs	126.7*67.8*15.2cm

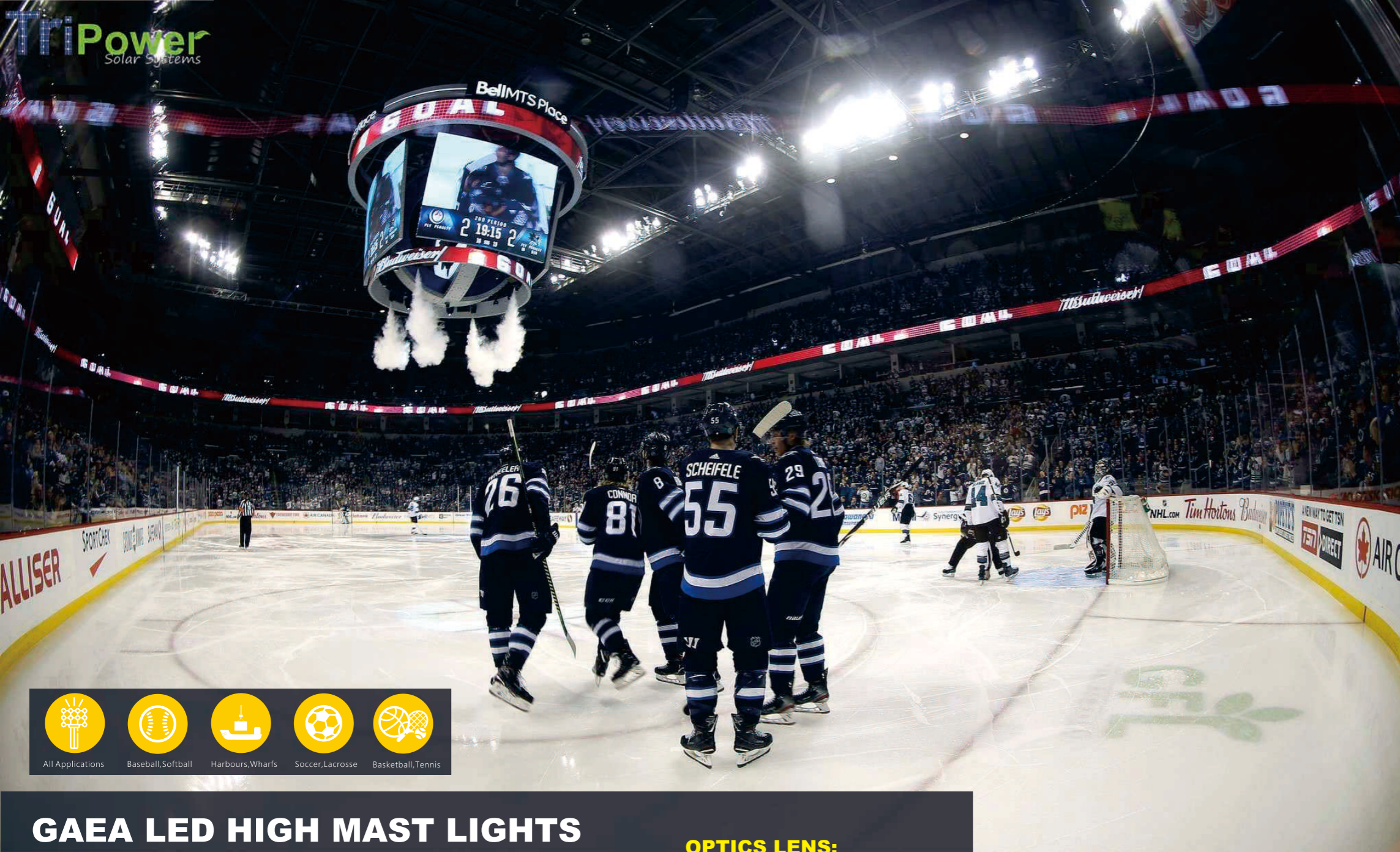

# GAEA LED HIGH MAST LIGHTS

240W 320W 480W 720W 960W 1200W 1440W

## OPTICS LENS:

20° / 40° / 60° / 90° / 140×100°

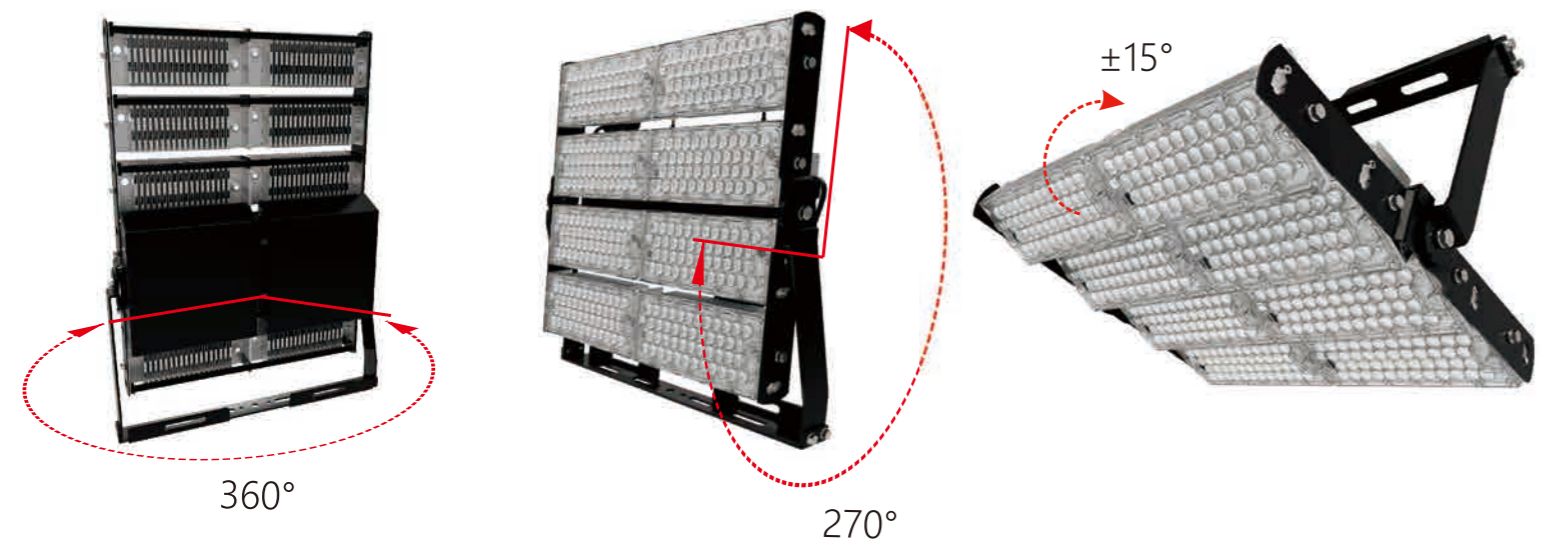
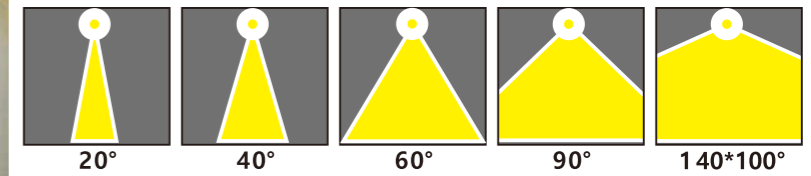

⚡ Input Voltage:	90-305VAC/480VAC	🎛 Dimming Options:	DALI/ DMX Dimmable
⚙ CCT:	3000K 4000K 5000K 5700K 6500K	☁ IP Rating:	IP66
📐 Beam Angle:	20° / 40° / 60° / 90° / 140°x100°	💡 Light Source:	Lumileds 5050

ITEM NO.	Wattage	Lumen	Efficiency	Driver	LED Chip	Dimensions
NL-GAEA-HM240	240W	38,400Lm	160Lm/W	1 x ELG-240-48A	92pcs	40.7x38x17.2 cm
NL-GAEA-HM320	320W	51,200Lm	160Lm/W	1 x ELG-320-48A	138pcs	51.2x40.7x17.2cm
NL-GAEA-HM480	480W	76,800Lm	160Lm/W	2 x ELG-240-48A	184pcs	64x40.7x17.2 cm
NL-GAEA-HM720	720W	115,200Lm	160Lm/W	3 x ELG-240-48A	276pcs	69.5x51.2x17.2cm
NL-GAEA-HM960	960W	153,600Lm	160Lm/W	4 x ELG-240-48A	368pcs	69.5x64.4x17.2cm
NL-GAEA-HM1200	1200W	192,000Lm	160Lm/W	5 x ELG-240-48A	460pcs	77.6x69.5x17.2cm
NL-GAEA-HM1440	1440W	230,400Lm	160Lm/W	6 x ELG-240-48A	552pcs	90.8x69.5x17.2cm



# HELIOS LED HIGH BAY LIGHTS

50W 100W 150W 200W 240W

OPTICS LENS : 30° / 60° / 90° / 120°

# HELIOS LED HIGH BAY LIGHTS

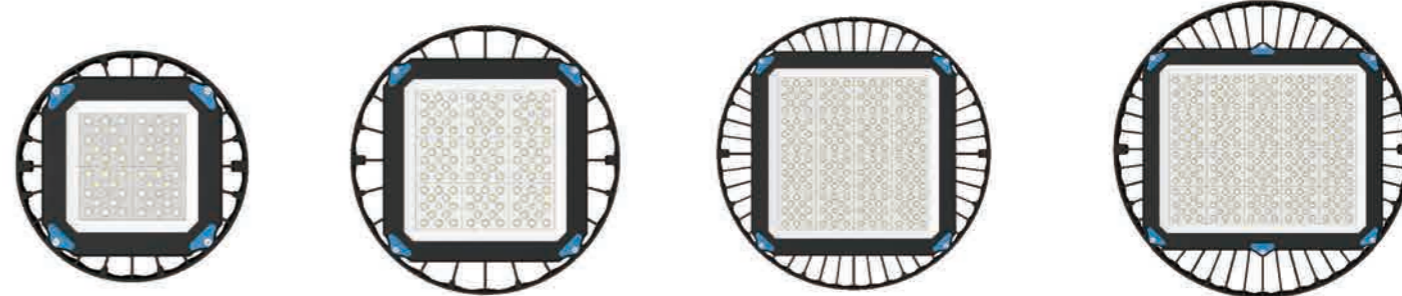

50W

100W

150W

200/240W

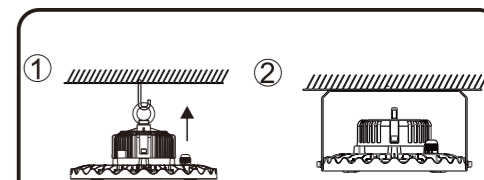
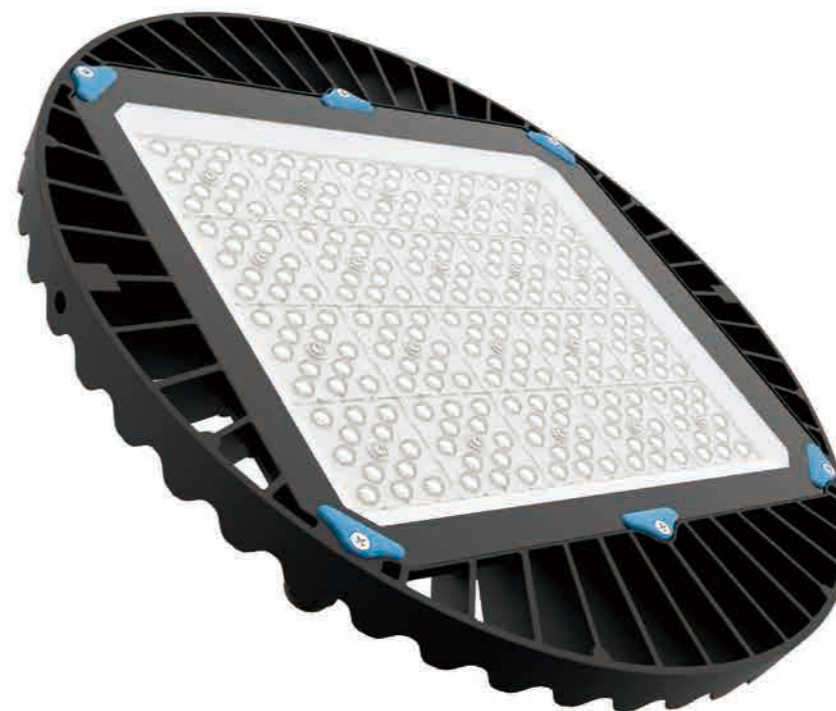

Hook/Bracket Mount



Tempered Glass

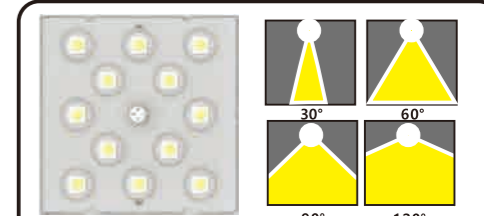

Various Beam Angle

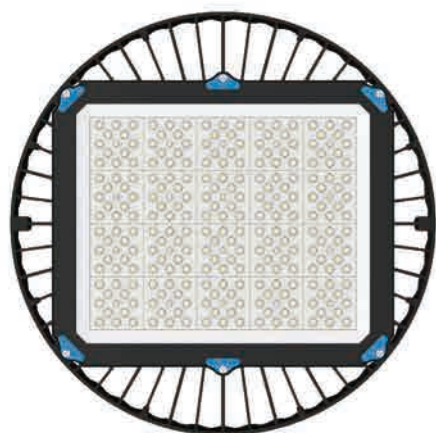

⚡ Input Voltage:	200-240/100-240VAC	🔘 Dimming Options:	DALI/ ZigBee Dimmable
⚙️ CCT:	3000K 4000K 5000K 5700K 6500K	☁️ IP Rating:	IP67
📐 Beam Angle:	30° / 60° / 90° / 120°	💡 Light Source:	Lumileds3030

ITEM NO.	Wattage	Lumen	Efficiency	Driver	LED Chip	Dimensions
NL-HELIOS-HB50	50W	7,000Lm	140Lm/W	NL-HBG-50	48pcs	φ215*97 mm
NL-HELIOS-HB100	100W	14,000Lm	140Lm/W	MW-HBG-100	108pcs	φ290*153 mm
NL-HELIOS-HB150	150W	21,000Lm	140Lm/W	MW-HBG-150	192pcs	φ362*153 mm
NL-HELIOS-HB200	200W	28,000Lm	140Lm/W	MW-HBG-200	240pcs	φ400*153 mm
NL-HELIOS-HB240	240W	33,600Lm	140Lm/W	MW-HBG-240	240pcs	φ400*163 mm

# MOON LED HIGH BAY LIGHTS



-  Automatic Switch ON/OFF
-  Motion Sensor
-  Delay Time Setting
-  Photo Sensor
-  Lux Setting While Waiting
-  Time Setting For Waiting
-  Remote Control

## MOON LED HIGH BAY LIGHTS

100W 150W 200W

OPTICS LENS : 60° / 90° / 120°

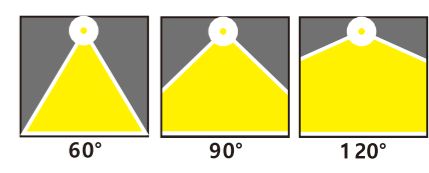
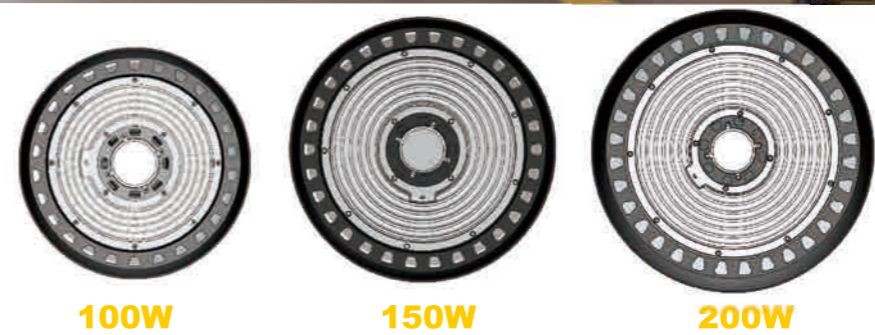

⚡ Input Voltage: 90-305VAC

⚙ Dimming Options: DALI/ DMX Dimmable

⚙ CCT: 3000K 4000K 5000K 5700K 6500K

☁ IP Rating: IP66

🔦 Beam Angle: 30° / 60° / 90° / 120°

🏠 Light Source: Lumileds3030

ITEM NO.	Wattage	Lumen	Efficiency	Driver	LED Chip	Dimensions
NL-MOON-UHB-100	100W	15,000Lm	150Lm/W	MW-ELG-100	140pcs	Ø290*150mm
NL-MOON-UHB-150	150W	22,500Lm	150Lm/W	MW-ELG-150	210pcs	Ø340*157mm
NL-MOON-UHB-200	200W	30,000Lm	150Lm/W	MW-ELG-200	280pcs	Ø380*160mm



# THEA LED FLOOD LIGHTS

10W 20W 30W 50W 80W 100W 120W 150W 180W 200W 240W 300W

**OPTICS LENS : 30° / 60° / 90° / 120°**



# THEA LED FLOOD LIGHTS



## MAIN FEATURES

- High efficiency, 130lm/W available.
- Beam angle 30°/60°/90°/120°
- Ultra Slim Integrated Die-casting aluminum housing, Elegant appearance, Good heat dissipation, long lifespan
- Tempered glass, surface coating process, excellent corrosion-proof

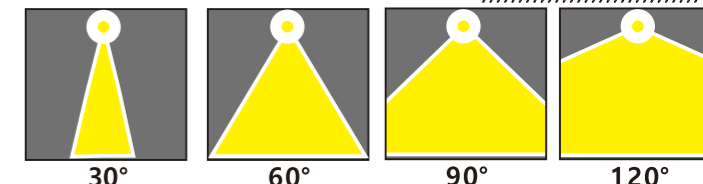

**Input Voltage:** 90-305VAC

**CCT:** 3000K 4000K 5000K 5700K 6500K

**Beam Angle:** 30° / 60° / 90° / 120°

**Dimming Options:** DALI/ ZigBee Dimmable

**IP Rating:** IP67

**Light Source:** Lumileds3030

ITEM NO.	Wattage	Lumen	Efficiency	Driver	LED Chip	Dimensions
NL-THEA-FL10	10W	1,300Lm	130Lm/W	Quality Driver	12pcs	182*122*47mm
NL-THEA-FL20	20W	2,600Lm	130Lm/W	Quality Driver	24pcs	242*169*51mm
NL-THEA-FL30	30W	3,900Lm	130Lm/W	Quality Driver	36pcs	242*169*51mm
NL-THEA-FL50	50W	6,500Lm	130Lm/W	Quality Driver	72pcs	282*204*52mm
NL-THEA-FL80	80W	10,400Lm	130Lm/W	Quality Driver	96pcs	337*269*52mm
NL-THEA-FL100	100W	13,000Lm	130Lm/W	Meanwell/Inventronics	120pcs	394*394*56mm
NL-THEA-FL120	120W	15,600Lm	130Lm/W	Meanwell/Inventronics	160pcs	394*394*56mm
NL-THEA-FL150	150W	19,500Lm	130Lm/W	Meanwell/Inventronics	180pcs	445*392*56mm
NL-THEA-FL180	180W	23,400Lm	130Lm/W	Meanwell/Inventronics	240pcs	445*392*56mm
NL-THEA-FL200	200W	26,000Lm	130Lm/W	Meanwell/Inventronics	240pcs	497*392*56mm
NL-THEA-FL240	240W	31,200Lm	130Lm/W	Meanwell/Inventronics	320pcs	497*392*56mm
NL-THEA-FL300	300W	39,000Lm	130Lm/W	Meanwell/Inventronics	384pcs	503*545*64mm



# RHEA LED FLOOD LIGHTS



**30W/50W 100W 150W 200W 300W 400W 600W 800W**



## MAIN FEATURES

- High efficiency, 150lm/W available.
- Beam angle 30°/60°/90°/80\*140°/80\*150°
- Photosensor/Motion Sensor
- Ultra Slim Die-casting aluminum housing, Elegant appearance, Good heat dissipation, Long lifespan
- Tempered glass, surface coating process, excellent corrosion-proof

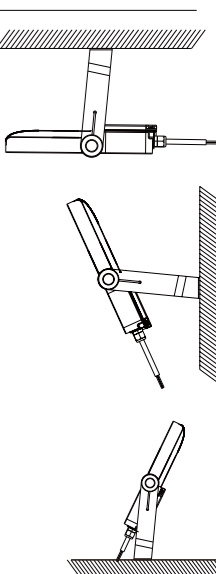

# RHEA LED FLOOD LIGHTS

**30W 50W 100W 150W 200W 300W 600W 800W**

**OPTICS LENS : 30° / 60° / 90° / 80\*140° / 80\*150°**



<b>Input Voltage:</b>	90-305VAC	<b>Dimming Options:</b>	DALI/ ZigBee Dimmable
<b>CCT:</b>	3000K 4000K 5000K 5700K 6500K	<b>IP Rating:</b>	IP67
<b>Beam Angle:</b>	30° / 60° / 90° / 80*140° / 80*150°	<b>Light Source:</b>	Lumileds3030/5050

ITEM NO.	Wattage	Lumen	Efficiency	Driver	LED Chip	Dimensions
NL-RHEA-FL30	30W	5,100Lm	170Lm/W	Meanwell/Inventronics	48pcs	346*200*65mm
NL-RHEA-FL50	50W	8,500Lm	170Lm/W	Meanwell/Inventronics	48pcs	346*200*65mm
NL-RHEA-FL100	100W	17,000Lm	170Lm/W	Meanwell/Inventronics	96pcs	365*310*60mm
NL-RHEA-FL150	150W	25,500Lm	170Lm/W	Meanwell/Inventronics	144pcs	365*365*60mm
NL-RHEA-FL200	200W	34,000Lm	170Lm/W	Meanwell/Inventronics	192pcs	365*420*60mm
NL-RHEA-FL300	300W	51,000Lm	170Lm/W	Meanwell/Inventronics	288pcs	590*387*63mm
NL-RHEA-FL400	400W	68,000Lm	170Lm/W	Meanwell/Inventronics	384pcs	695*355*60mm
NL-RHEA-FL600	600W	102,000Lm	170Lm/W	Meanwell/Inventronics	576pcs	740*620*95mm
NL-RHEA-FL800	800W	136,000Lm	170Lm/W	Meanwell/Inventronics	768pcs	740*730*95mm



# THOR LED STREET LIGHTS

50W 100W 150W 200W 240W 300W

OPTICS LENS : Type III (80\*140°) / 30° / 60° / 90°



## THOR LED STREET LIGHTS



50W 100W 150W 200W 240W 300W



Photosensor  
Intelligent device Box



Elegant Die-casting Alu

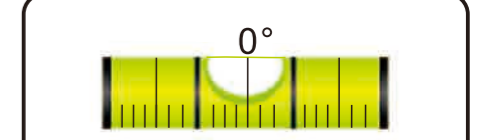

Spirit Level ,Easy to install



Adjustable/ Straight Arm



⚡ Input Voltage:	90-305VAC	🔘 Dimming Options:	DALI/ ZigBee Dimmable
⚙ CCT:	3000K 4000K 5000K 5700K 6500K	☁ IP Rating:	IP67
📐 Beam Angle:	Type III (80*140°)/30° / 60° / 90°	💡 Light Source:	Lumileds3030/5050

ITEM NO.	Wattage	Lumen	Efficiency	Driver	LED Chip	Dimensions
NL-THOR-SL50	50W	8,500Lm	170Lm/W	Inventronics-50	48pcs	471*320*88mm
NL-THOR-SL100	100W	17,000Lm	170Lm/W	Inventronics-100	96pcs	542*320*88mm
NL-THOR-SL150	150W	25,200Lm	170Lm/W	Inventronics-150	144pcs	613*320*88mm
NL-THOR-SL200	200W	34,000Lm	170Lm/W	Inventronics-200	192pcs	684*320*88mm
NL-THOR-SL240	240W	40,800Lm	170Lm/W	Inventronics-240	240pcs	755*320*88mm
NL-THOR-SL300	300W	51,000Lm	170Lm/W	Inventronics-300	288pcs	826*320*88mm

# ZEUS LED AREA LIGHTS

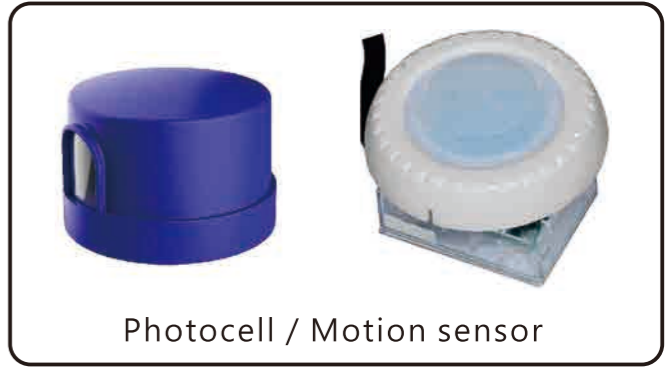
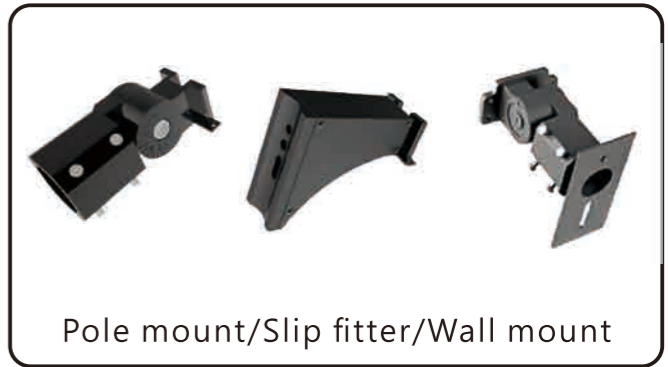

## ZEUS LED AREA LIGHTS

75W 100W 150W 200W 240W 300W

**OPTICS LENS :** Type III 80°\*150°  
Type IV 80°\*155°  
Type V 150°



⚡ Input Voltage:	90-305VAC	🎛 Dimming Options:	DALI/ ZigBee Dimmable
⚙ CCT:	3000K 4000K 5000K 5700K 6500K	☁ IP Rating:	IP67
📐 Beam Angle:	Type III / Type IV / Type V	💡 Light Source:	Lumileds3030

ITEM NO.	Wattage	Lumen	Efficiency	Driver	LED Chip	Dimensions
NL-ZEUS-PL75	75W	12,750Lm	170Lm/W	Inventronics-75	96pcs	300*320*135mm
NL-ZEUS-PL100	100W	17,000Lm	170Lm/W	Inventronics-100	144pcs	300*320*135mm
NL-ZEUS-PL150	150W	25,200Lm	170Lm/W	Inventronics-150	192pcs	320*420*135mm
NL-ZEUS-PL200	200W	34,000Lm	170Lm/W	Inventronics-200	252pcs	320*420*135mm
NL-ZEUS-PL240	240W	40,800Lm	170Lm/W	Inventronics-240	324pcs	325*600*135mm
NL-ZEUS-PL300	300W	51,000Lm	170Lm/W	Inventronics-300	432pcs	325*600*135mm